

---

# TBS POWERCUBE - Multirotor Stack *patented!*

*All-in-one racing flight control, speed control and power distribution*

Revision 2017-03-09

The next generation plug&play RACE system. Design optimized for ultimate performance and reliability. Compatible with any multi-rotor frame.

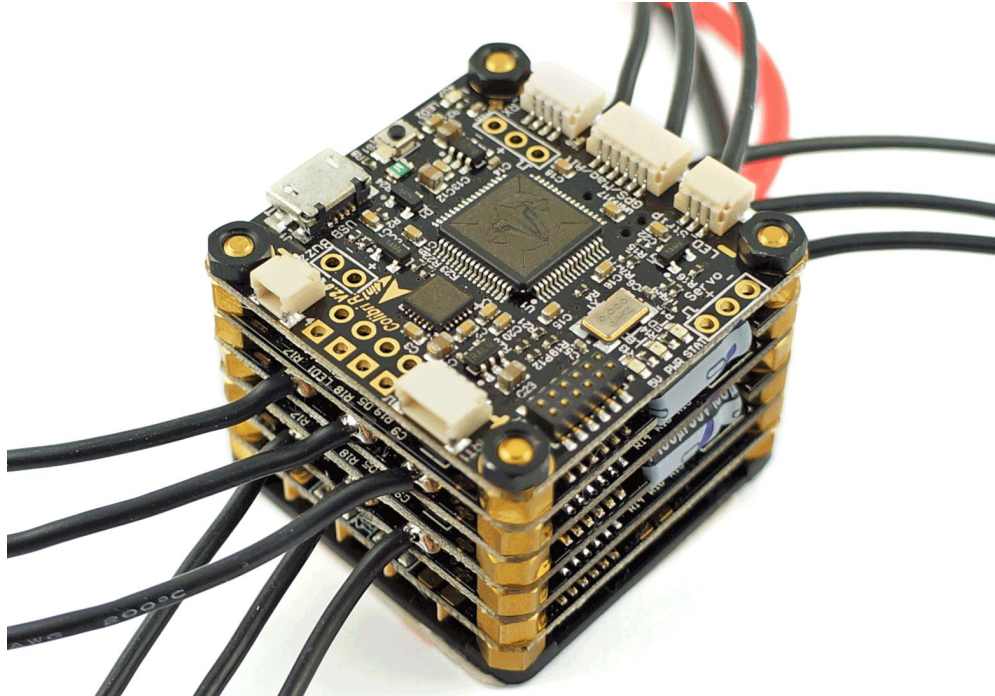

## Key features

- Ultra-lightweight and high-performance multi-rotor stack
- Designed to be bundled and sold with any 120 to 330mm size frame
- Stacked boards for extreme durability
- Based on fast STM32F3 flight controller
- Innovative patent-pending wire-free power distribution through stand-offs
- True plug & play, no soldering required
- Cost-efficient and field-repairable
- Tested, developed and flown by the world's leading pilots
- Highest quality aluminum screws, brass standoffs and electronic components
- Standard 36x36mm dimension, 70g incl. PDB, wires & connectors
- Upgradable from compact to extreme configurations



## Specifications

TBS COLIBRI - Flight control layer	
<b>Hardware:</b>	<ul style="list-style-type: none"> <li>• STM32F303RCT6 72MHz 256kB MCU/FPU</li> <li>• MPU6000 3-axis Gyro <b>NEW!</b></li> <li>• Separate ultra-low noise LDO for IMU <b>NEW!</b></li> <li>• Auto resettable polyfuse to protect the FC against short circuits <b>NEW!</b></li> <li>• ESC connection pads for 4 ESC <b>NEW!</b></li> <li>• Motor PWM auto-connecting PWM/OneShot/Multishot signals</li> <li>• Bootloader tactile switch for easy firmware update</li> <li>• 5V for receiver and FC over internal BUS System</li> </ul>
<b>Software:</b>	<a href="http://www.team-blacksheep.com/powercube/colibri-latest.zip">Cleanflight</a> or <a href="http://www.team-blacksheep.com/powercube/colibri-latest.zip">Betaflight</a> with BST and pass-through ESC support, firmware: <a href="http://www.team-blacksheep.com/powercube/colibri-latest.zip">http://www.team-blacksheep.com/powercube/colibri-latest.zip</a>
<b>Compatibility:</b>	Tri-, quad- and hexacopters
<b>In/outputs:</b>	<ul style="list-style-type: none"> <li>• 1x Receiver port - PPM, SBUS or SPEKTRUM (PPM, UART2, 5V, 3.3V)</li> <li>• 1x RGB LED driver port with regulated 5V</li> <li>• 1x GPS/compass/altitude port (UART3, I2C, 5V)</li> <li>• 1x UART serial port (UART1)</li> <li>• 1x Piezo buzzer port for active driven buzzers</li> <li>• 1x Internal BUS system (6x PWM, 1x BST, 5V, 12V)</li> <li>• 4x ESC solder pads <b>NEW!</b></li> <li>• 1x Servo Output for tricopters or any Servo function</li> <li>• 2x VBatt (North-East &amp; South-West corner)</li> <li>• 2x GND Batt (North-West &amp; South-East corner)</li> <li>• 1x USB port (STM VCP)</li> <li>• 1x Push button - DFU boot mode</li> </ul>
<b>Connectors:</b>	JST-SH 1.00mm with 2.54mm pin header

TBS BULLETPROOF 20A - Speed control layer(s)									
<b>Firmware:</b>	TBS 20A, BLHeli 14.6 , SimonK customized available								
<b>Supports:</b>	OneShot, active/regenerative braking, safety cut-off (simonk)								
<b>Hardware:</b>	<ul style="list-style-type: none"> <li>• 1x ATmega8A MCU</li> <li>• Electrolytic capacitors - crash resistance!</li> <li>• Efficient high-performance FET drivers</li> </ul>								
<b>Maximums:</b>	<table border="1"> <thead> <tr> <th>Current draw</th> <th>Supply voltage</th> </tr> </thead> <tbody> <tr> <td>20A constant - with 5mph airflow</td> <td>2S, 3S, 4S, 5S, 6S compatible</td> </tr> <tr> <td>30A constant - with good airflow</td> <td></td> </tr> <tr> <td>45A burst, 10 seconds</td> <td></td> </tr> </tbody> </table>	Current draw	Supply voltage	20A constant - with 5mph airflow	2S, 3S, 4S, 5S, 6S compatible	30A constant - with good airflow		45A burst, 10 seconds	
Current draw	Supply voltage								
20A constant - with 5mph airflow	2S, 3S, 4S, 5S, 6S compatible								
30A constant - with good airflow									
45A burst, 10 seconds									
<b>In/outputs:</b>	<ul style="list-style-type: none"> <li>• 2x VBatt (North-East &amp; South-West corner)</li> <li>• 2x GND batt (North-West &amp; South-East corner)</li> <li>• 1x Internal BUS-system (6x PWM, BST, 5V, 12V)</li> <li>• 1x PWM-pads for custom installations</li> <li>• 3-phase brushless motor output</li> </ul>								



<b>TBS PDB V2 with integrated DCDC - Power distribution and power supply layer (NEW!)</b>	
<b>Power distribution:</b>	100A max. continuous current, 150A burst
<b>Current sensor:</b>	100A, 0.1A resolution, 2% accuracy, BST-compatible (e.g for TBS CORE PRO)
<b>Inputs:</b>	<ul style="list-style-type: none"> <li>• 1x Battery V+ and GND, 150A max</li> <li>• 1x Internal BUS system (6x PWM, BST, 5V, 12V)</li> </ul>
<b>Ports:</b>	<ul style="list-style-type: none"> <li>• CAM - FPV camera port, 5V/12V selectable on PCB (factory set to 12V)</li> <li>• VTX - FPV video transmitter port, 5V/12V/VBat selectable on PCB (factory set to 5V)</li> <li>• BST - BlackSheep Telemetry port, connects to TBS CORE PRO OSD</li> </ul>
<b>Power supply:</b>	5V @ 4A <b>NEW!</b> , 12V @ 0.2A, combined max. draw
<b>Connectors:</b>	Molex Picoblade 1.25mm, 4-pin for VTX and CAM, 5-pin for BST

<b>TBS POWERCUBE - Stack details</b>	
<b>Working temperature:</b>	0°C to 85°C
<b>Dimensions:</b>	36 x 36 x 30mm (with 4 ESCs)
<b>Weight:</b>	70g - brass standoff version 62g - aluminum-gold standoff version (available in PRO tuning kit)
<b>Basic kit contents:</b>	<ul style="list-style-type: none"> <li>• 1x TBS COLIBRI V2.0 flight control <b>NEW!</b></li> <li>• 4x TBS BULLETPROOF speed control w/2mm female bullet connector</li> <li>• 1x TBS PDB V2 w/ XT60 connector <b>NEW!</b></li> <li>• 1x Plastic isolation layer</li> <li>• 1x PPM/SBUS cable</li> <li>• 1x Spektrum cable</li> <li>• 1x Piezo buzzer</li> <li>• 1x LED pigtail</li> </ul>

<b>TBS FPVision OSD/VTX - CORE PRO OSD, Video Transmitter, Power Distribution and Power Supply</b>	
<b>Power distribution:</b>	100A max. continuous current, 150A burst
<b>Current sensor:</b>	100A, 0.1A resolution, 2% accuracy
<b>Inputs:</b>	<ul style="list-style-type: none"> <li>• 1x Battery V+ and GND, 150A max.</li> <li>• 1x Internal BUS system (6x PWM, BST, 5V, 12V)</li> <li>• 1x VTX menu button</li> </ul>
<b>Ports:</b>	<ul style="list-style-type: none"> <li>• 2x CAM - FPV cam port, 5V/12V selectable via TBS Agent (5V default)</li> <li>• 1x BST - BlackSheep Telemetry port, connects to TBS ecosystem</li> <li>• 1x U.FL SMD VTX antenna connector</li> </ul>
<b>Power supply:</b>	5V @ 4A, 12V @ 0.2A, combined max. draw
<b>Connectors:</b>	Molex Picoblade 1.25mm, 4-pin for CAM inputs, 5-pin for BST



---

## Attention

The TBS POWERCUBE, when installed, can easily damage property or extremities if not used properly. Always ensure that no propellers are installed when configuring, installing or tuning your multirotor. We also recommend to use the options "Spin motor when armed" and use stick commands to arm your multirotor, rather than switches.

NEVER leave the platform powered on and unattended. Always check proper failsafe (power down) functionality, and try not to break too many laws while flying FPV (TBS can not be held responsible is what we are saying.)

Only disassemble/reassemble with proper tools! Take extra care to components that are situated around the standoffs. Check the maintenance section before attempting to open up the PowerCube!



---

# Table of content

## [Attention](#)

### [TBS POWERCUBE Overview](#)

## [Installation](#)

[Mounting on your frame](#)

[Carbon fiber frames](#)

[Finalizing your installation](#)

[The first flight](#)

### [TBS POWERCUBE on the TBS VENDETTA quadcopter](#)

### [TBS FPVision - CORE PRO OSD, UNIFY PRO VTX, VID SWITCH, BEEPER, DCDC](#)

[RC Calibration - Push button](#)

[Camera port switch](#)

[FPV Camera OSD control](#)

[Camera 5V/12V software selector](#)

[Board connection diagram](#)

### [TBS COLIBRI V2 - Flight control](#)

#### [Overview and connections](#)

[North](#)

[East](#)

[South](#)

[West](#)

#### [Configuration and tuning](#)

[Default Values](#)

[Driver installation](#)

[Updating firmware using TBS Agent \(recommended\)](#)

[Updating firmware using CleanFlight](#)

[Upgrade via CleanFlight](#)

[CleanFlight Configurator issues](#)

[Upgrade via DFU \(developer use\)](#)

### [TBS BULLETPROOF 25A ESC - Speed control](#)

[Configuration](#)

[Firmware upgrades](#)

[ESC / Interface table](#)

### [TBS POWERCUBE PDB V2 - Power distribution](#)

[Selecting VTX and CAM voltage](#)

[Connecting FPV camera and transmitter](#)

[Making older TBS PDB V1 compatible with newer TBS COLIBRI FC](#)

[Troubleshooting FPV Transmitter / Camera](#)



---

[TBS Elite Bundle / External ESC PDB layer](#)

[TBS POWERCUBE Drag Race Shield](#)

[Connecting TBS equipment](#)

[Connectivity with TBS CORE PRO OSD](#)

[TBS CORE PRO Connection](#)

[Entering OSD configuration menu](#)

[RC Calibration \(mandatory\)](#)

[Calibrate new setup](#)

[Read RC data from existing setup](#)

[Maintenance](#)

[Replacing components](#)

[Tuning](#)

[Troubleshooting](#)

[Good practices](#)



# TBS POWERCUBE Overview

Check out the POWERCUBE in all its glory. The following diagrams indicate the locations of each component and their purpose.

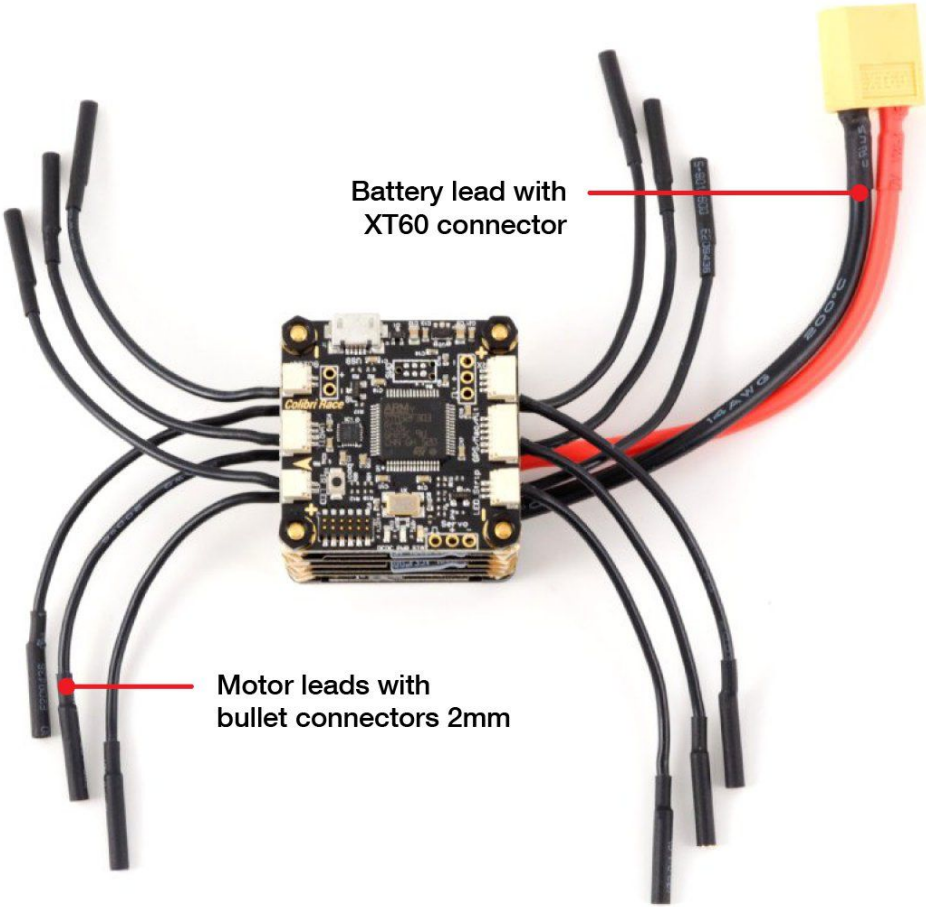
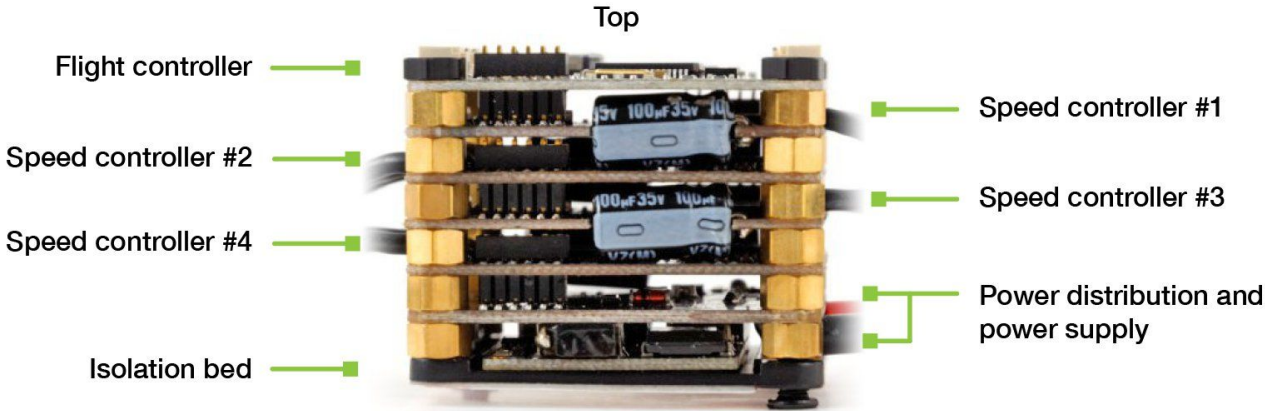

---

## Installation

### Mounting on your frame

The TBS POWERCUBE should be placed in the same spot where the flight controller is normally installed. The TBS POWERCUBE carries power (VBatt, GND) over the four standoffs in the corners, alternating between VBatt and GND. For this reason, the two screws carrying power (VBatt) are hidden underneath the double sided sticky tape on the bottom of the TBS POWERCUBE. The tape isolates them from the carbon fiber frame. The ground-carrying standoffs should be used to bolt the TBS POWERCUBE onto the frame. In combination with the tape, this creates a very solid mount.

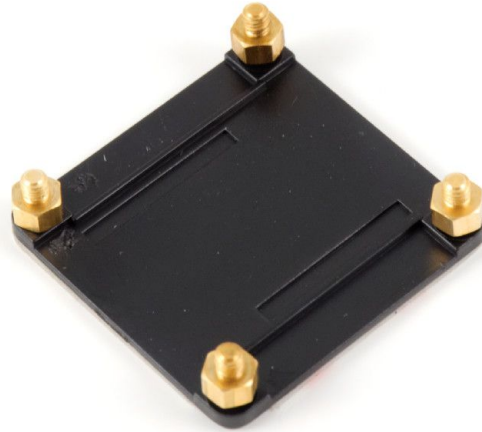

The corners on the top layer indicates the polarity of the power, i.e. "+" for VBatt and "-" for GND, as shown in the image below.

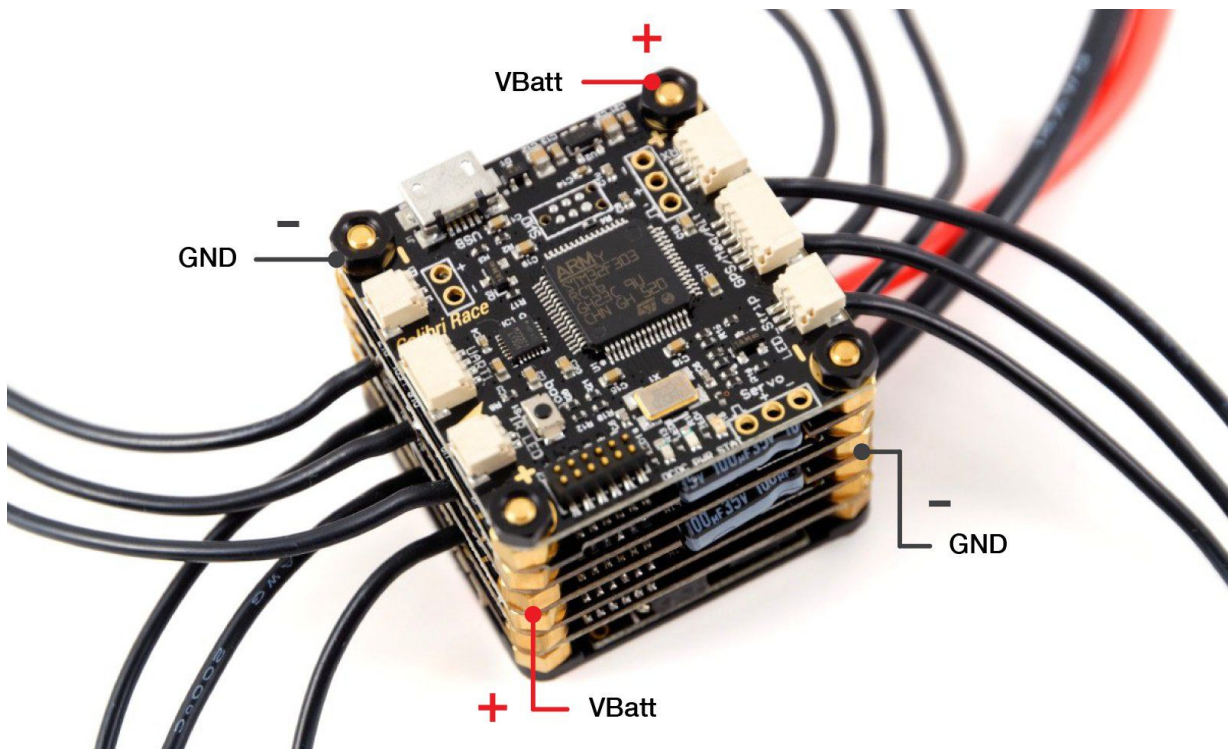



Installed from the factory are super-lightweight M3 aluminum screws. They are anodized to protect against short circuits. The provided mounting screws are made for frames up to 2mm thickness. If your frame is thicker, please use below table to find the correct screw length:

Frame thickness:	Recommended mounting screw length:
1.6mm	M3x6 (included in kit)
2mm	M3x6 (included in kit)
2.5mm	M3x7
3mm	M3x7
4mm	M3x8
5mm	M3x9

## Carbon fiber frames

Carbon fiber frames can conduct electricity, therefore the lower plastic isolator bed must be used. If you are mounting the stack onto power distribution boards or G10 frames, you can use smaller nylon washers or stand-offs (3mm shorter) instead of the plastic isolation bed.

Frame type:	Mounting options:
G10, other glass fiber materials	No plastic bed, mounting screws on all four corners
Carbon Fiber, FR4 with copper	Plastic bed required, mounting screws only on GND "-" corners

When using carbon fiber plates, make sure that you only screw the mounting (GND) screws through the frame, the power-carrying screws (VBatt) remain isolated inside the plastic bed.

Make sure that no power carrying elements can get in touch with the carbon frame except ground (Powercube GND, VTX antenna socket etc.).

Pay special attention to motor phases, also make sure the screws are not too long to push up into the motor windings.



---

## Finalizing your installation

If you have a multimeter handy, make a quick test if Vbatt and GND do not short. You do this with the “sound” or “Ohm” setting on your multimeter, and then probing on the 2 pins inside the XT60 connector. If there is no short (no beep and not reading 0.00 Ohm), connect a battery and a receiver. If you have a CORE PRO, you can now simply turn on your FPV display or goggles and run the calibration wizard. After this, all your channels are mapped correctly. If you are not using the CORE PRO, you will need to ensure that the channels are correctly mapped using the CleanFlight Configurator software and your R/C.



Then, start your motors and ensure they are spinning in the right direction. The arm command is yaw-right, throttle at zero. The motors will spin in idle. Verify that the motor directions matches the right diagram. If they do not match, you may need to flip two of the three connector cables. Also, now is a good time to double-and-triple check that motor 1, 2, 3 and 4 are wired up to the correct layer in the TBS POWERCUBE stack.

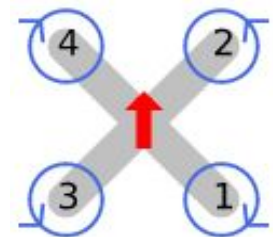

## The first flight

When preparing for the first flight, there are a couple of things to consider.

- 1) Do not move the model while plugging in the battery and during the first 4 to 5 seconds after powering up. During initialization the gyro must remain idle, otherwise the self-calibration will be wrong. If you have installed LEDs or a Buzzer, they will indicate when the model is ready to take off by 3 distinct beeps and solid LED color on all LEDs using the “Warnings” LED setting.
- 2) If the model immediately flips or rolls during take-off, verify that the TBS POWERCUBE flight controller is oriented in the correct way and that all motors are plugged into the correct position of the TBS PowerCube stack. The arrow on the board must face flight forward. Also, verify that the motor spin directions are correct.



---

## TBS POWERCUBE on the TBS VENDETTA quadcopter

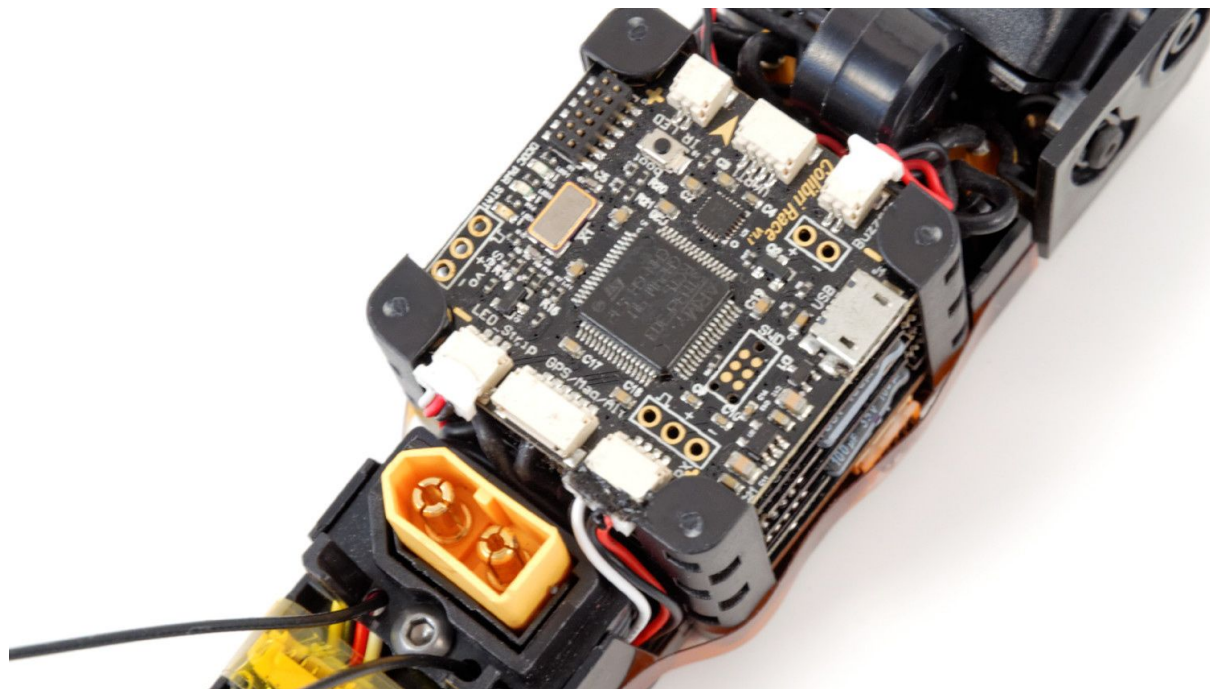

The TBS VENDETTA has a full POWERCUBE installed at its core. It powers the R/C receiver, flight control, motors, buzzer, LED backplate and DCDC power system. The OSD is powered by a separate TBS CORE PRO.

The instructions for the TBS VENDETTA can be found at:

<http://www.team-blacksheep.com/tbs-vendetta-manual.pdf>



---

## TBS FPVision - CORE PRO OSD, UNIFY PRO VTX, VID SWITCH, BEEPER, DCDC

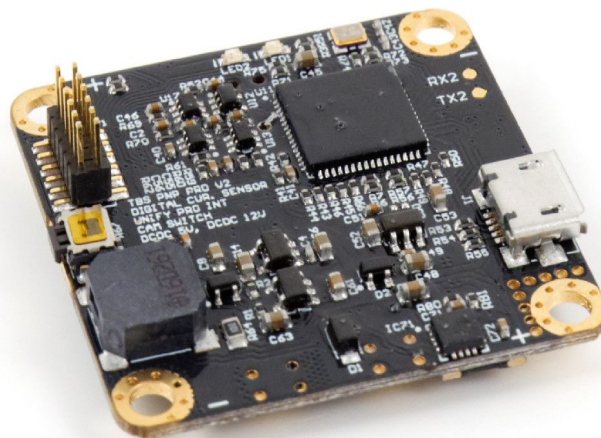

The TBS FPVision is a new layer for the POWERCUBE and it is our latest innovation (released October 2016). It packs a powerful punch in a small package, it combines the CORE PRO OSD, DCDC, UNIFY PRO 5G8 VTX, dual camera/switch and TBS 100A Current Sensor in one layer and replaces the normal DCDC layer. The current sensor can estimate your battery capacity and display accurate capacity remaining. The OSD engine was improved to support a variety of advanced display features, but still builds upon the CORE PRO stack. The TBS FPVision directly replaces the bottom layer (PDB V1 or V2) in the normal POWERCUBE stack, the Unify Pro VTx and the CORE PRO OSD in your build. The stacking height or other functionality is not affected.

For instructions on how to use the OSD, please consult the [TBS CORE PRO manual](#) as this is what is at the heart of the FPVision board. While for the VTX, check the [TBS UNIFY PRO VTX manual](#) in more detail.

There are some additional features built into the camera ports of the FPVision that the regular TBS CORE PRO does not support, which we will explain in the following sections.

### RC Calibration - Push button

The TBS FPVision only has a single push button available as an external input. Push it for 5 seconds to enter the OSD / RC Calibration mode, which you need to perform to provide further control to the TBS FPVision OSD.

### Camera port switch

There are two camera ports on the FPVision. In the OSD configuration menu, you can select which R/C channel that controls the camera switch. You can also reverse the direction of the channel.

### FPV Camera OSD control

Accessing the camera's OSD menu used to be a big hassle. Now, simply select "FPV CAMERA" menu from the CORE PRO OSD and you will get to access the camera's OSD (compatible with TBS ZeroZero V2, HS1177, Runcam Owl Plus / Swift, etc).



If the OSD times out, or you select EXIT, move your ROLL stick to left for 3 seconds to re-enter the CORE PRO OSD.

## Camera 5V/12V software selector

The camera port is set to 5V from the factory. To change the output voltage to 12V, connect the TBS FPVision to the [TBS Agent](#) (Windows software), and look for the CAM VOLTAGE property. You can toggle it between 5V and 12V. Be sure that your camera can support this voltage!

## Board connection diagram

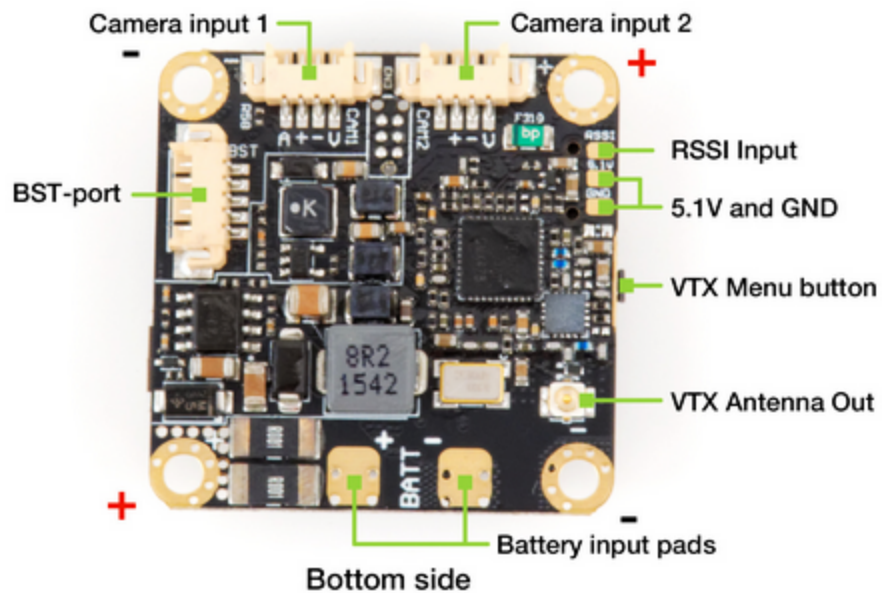
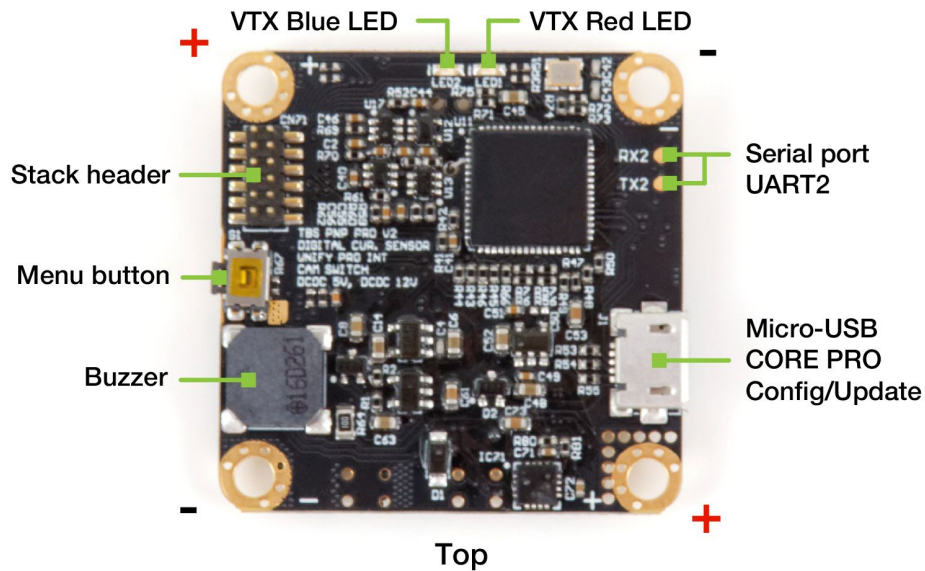

---

## TBS COLIBRI V2 - Flight control

The TBS COLIBRI RACE edition is a barebone version of the TBS COLIBRI (debuted in the TBS GEMINI), built specifically for the TBS POWERCUBE. Flashed by default with Cleanflight to allow maximum tuning capabilities for racers, with multiple innovative features such as built-in IR port, MPU6500 with serial support (insanely low looptimes!!), USB VCP, JST-SH plug&play ports, as well as solder sockets for the most critical input and outputs for seasoned builders.

**Note:** TBS COLIBRI V2 is only compatible with TBS PDB V2, only use V2 FC on V2 PDB.

- STM32F303 based chipset for ultimate performance
- PPM, SBUS, DSM, DSMX input (5V and 3.3V provided over internal BUS)
- 6 PWM ESC output channels (autoconnect, internal BUS)
- Choose between plug&play sockets or solder pads for R/C and buzzer
- 36x36mm standard size (30.5mm grid)
- RGB LED strip support incl. power management
- Extension port for GPS/external compass/pressure sensor
- UART serial port for peripherals (Crossfire CRSF, Blackbox, FrSky telemetry etc.)
- 5V buzzer output
- MPU6000 (**NEW!**) accelerometer/gyro sensors
- Runs Cleanflight/ Betaflight software
- 3x status LED (DC-DC Pwr/3.3V Pwr/Status)
- Weight only 4.4g

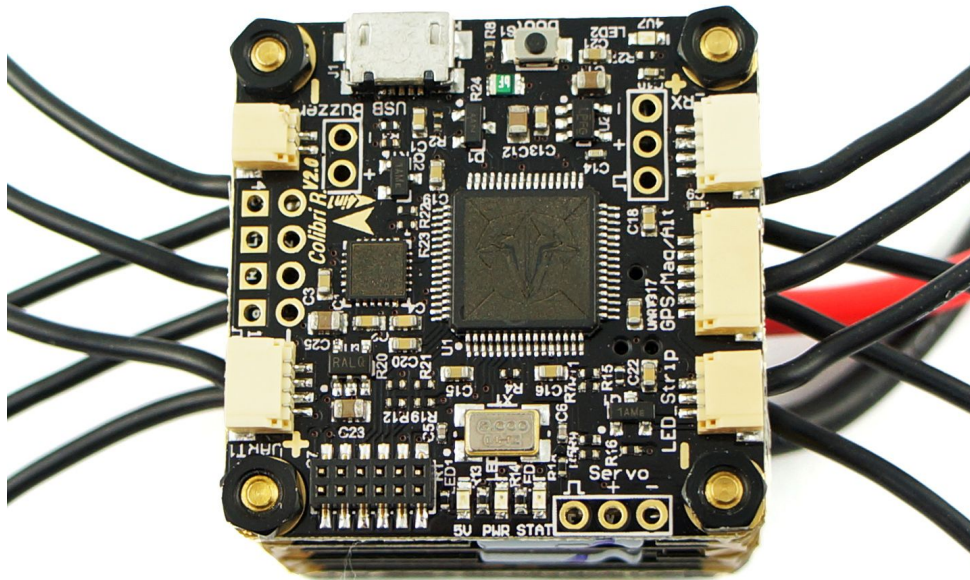

## Overview and connections

An overview of all the ports provided by the COLIBRI RACE flight controller is shown in the illustration below. Connect your peripherals according to your requirements. Pin-out is also printed on the underside of the PCB.

### North

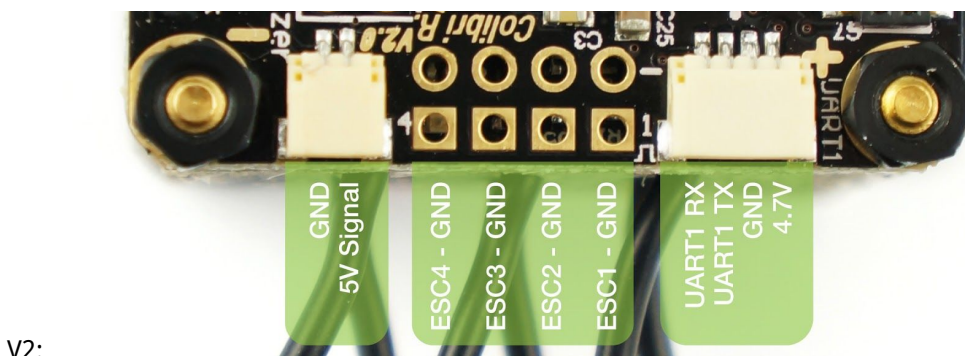
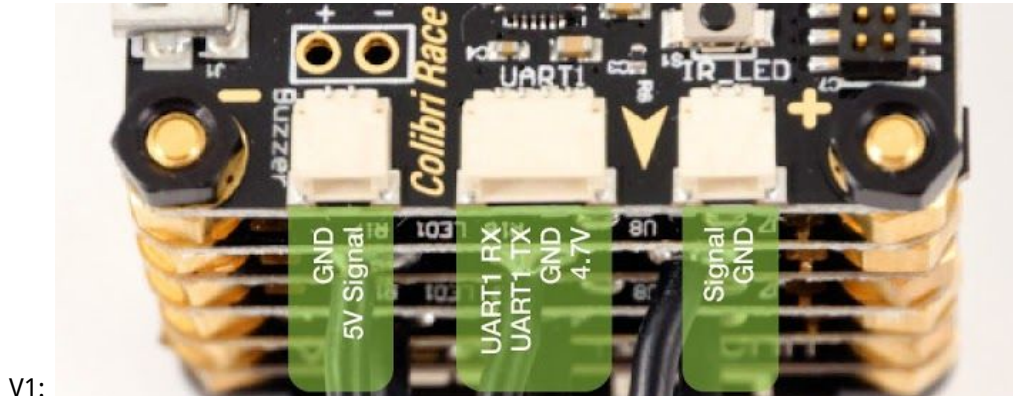

- **Buzzer** - Accepts any active driven buzzer on 5V, alarms can be set in CleanFlight/BetaFlight GUI
  - Pin-out from left: GND / 5V Buzzer Signal
  - Additional soldering pads for direct soldering (first batch has reverse signed + and - pads!)
- **ESC Outputs (V2)** - Control signal output connector for 4 ESCs
  - Pin-out from left: ESC4&GND / ESC3&GND / ESC2&GND / ESC1&GND
  - These are not used when part of the TBS POWERCUBE, then there are pads on the PDB V2
- **UART1** - Serial communication port
  - Pin-out from left: UART1 RX / UART1 TX / GND / 5V
- **IR\_LED (V1)** - IR LED use for lap timing
  - Pin-out from left: Signal / GND
- **Boot button (V1)** - Boot button for flashing new firmware
  - Button must be pressed to get into the DFU firmware loader mode



## East

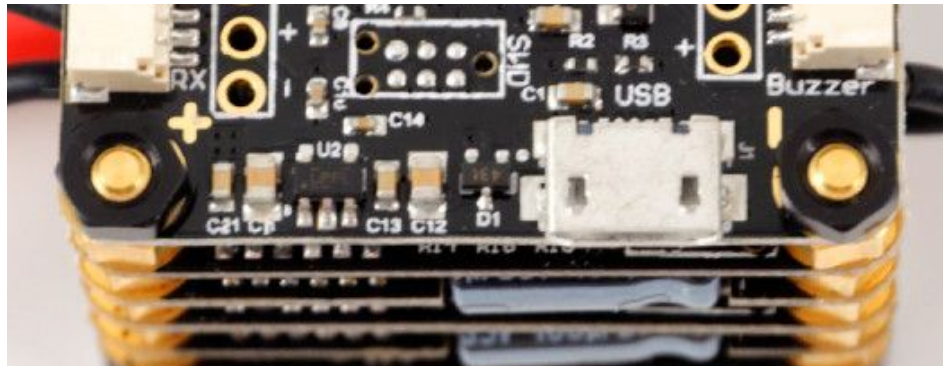

V1:

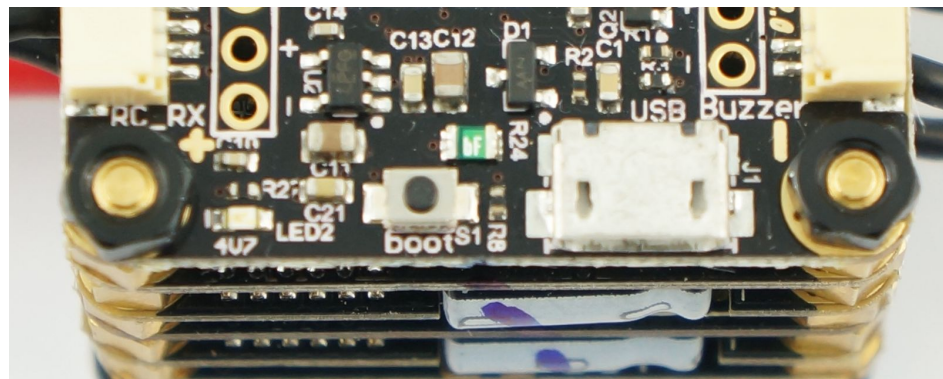

V2:

- **Micro-USB** - Connect via USB for configuration via CleanFlight/BetaFlight and firmware upgrades
- **SWD header (V1)** - Used for direct microcontroller programming
- **Boot button (V2)** - To enter DFU mode for firmware upgrade





## South

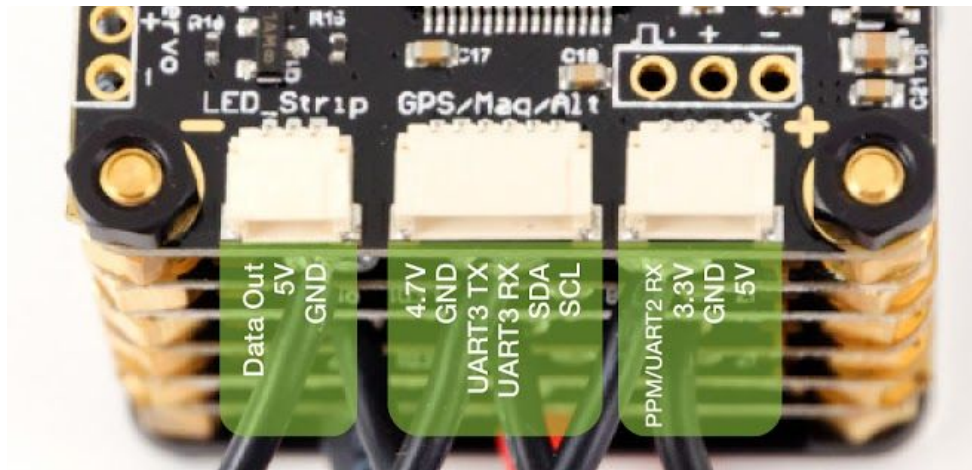

V1&V2:

- **LED\_Strip** - For directly connecting WS2812B, WS2812, and WS2811 based RGB LED strips
  - Regulated 5V PWR provided to connector over internal BUS, no additional voltage regulator required!
  - Any WS2812B LED boards with up to 32 LEDs should work
  - Pin-out from left: Data Out / 5V / GND
  - Signal-pin connects to DIN on WS28xx pads
- **GPS/Mag/Alt (UART3)** - Connector for external GPS, magnetometer and altitude sensors - or other uses, can be configured in Cleanflight/BetaFlight.
  - Pin-out from left: 5V / GND / UART3 TX / UART3 RX / SDA / SCL
- **RC\_RX** - Two receiver signal connectors, supports: PPM, S.BUS, SPEKT, DSM, DSMX
  - Pin-out from left: PPM, UART2 RX / 3.3V / GND / 5V
  - Additional 2.54mm pitch soldering pads available for direct soldering receiver signal



## West

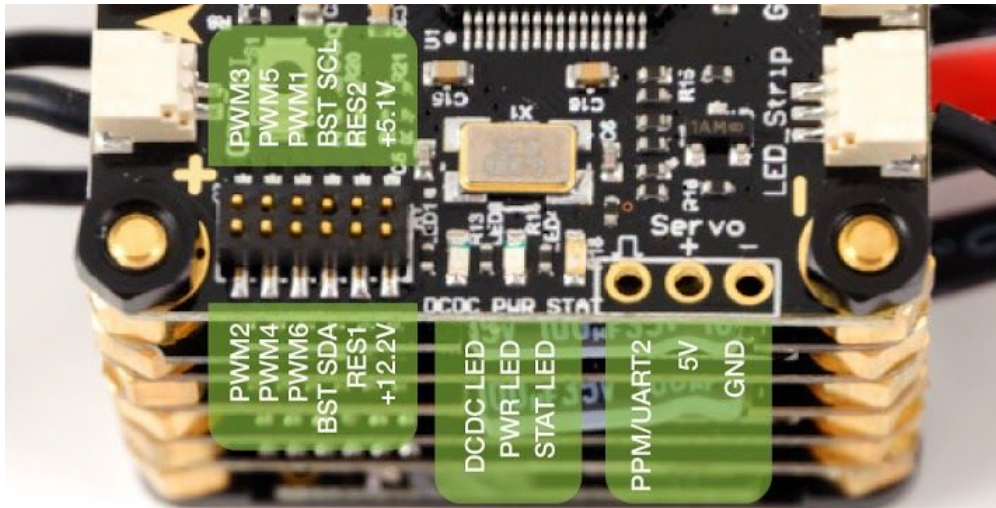

V1&V2:

Stacking header pin-out:

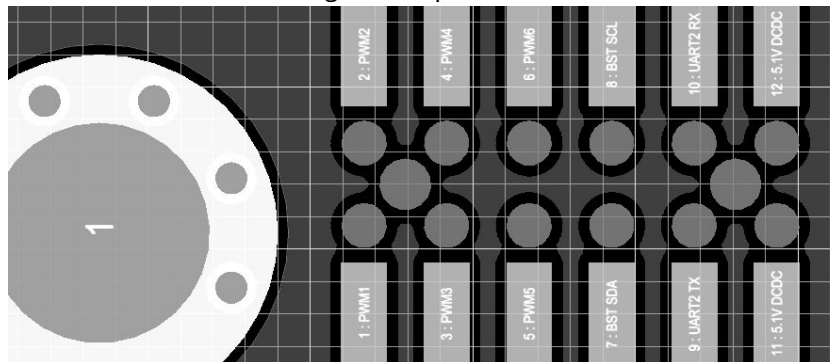

- **Stacking header** - Connecting the different layers in the stack
  - Top row: PWM2, PWM4, PWM6, BST SCL, UART2\_RX, +5V
  - Bottom row: PWM1, PWM3, PWM5, BST SDA, UART2\_TX, +5V PDB V2 and FPVision (**NEW!**) / +12V PDB V1
- **LEDs** - Status indicator
  - DCDC LED, lights up once 12V is available over internal BUS
  - PWR control LED, controlled via CleanFlight/BetaFlight
  - STAT LED, controlled via CleanFlight/BetaFlight
- **Servo** - One Servo output (for tricopters) with 3-pins for PWM / 5V / GND
  - 5V is provided from internal BUS



## Configuration and tuning

The COLIBRI RACE runs Cleanflight by default. Cleanflight comes with a great and easy to use Chrome Application that you can download here:

- [CleanFlight Configurator](#)

There are several very detailed CleanFlight guides available, which teaches you how to tune, configure and calibrate your model (see FliteTest and Oscar Liang's guides below). It would be impractical for this manual to regurgitate all of this. However, please do ensure that the parameter values specified in the following section are set in the configurator for proper control of the ESCs and aircraft.

- [FliteTest: Naze32 Tutorial](#)
- [PID Tuning Explained](#)

## Default Values

The ideal parameter values for COLIBRI with the BULLETPROOF 20A ESCs are shown in the following screen capture. Open CleanFlight and make sure all the fields are set to the corresponding values. The ESCs come pre-calibrated out of the box, there is no need to calibrate the servo range or do any other setup on the ESCs.

The screenshot displays the CleanFlight configurator interface with several sections highlighted by red boxes. The Mixer section shows a Quad X configuration with a red arrow pointing to the center. The ESC/Motor Features table has the ONESHOT125 feature checked and highlighted. The Accelerometer Trim section shows all trim values set to 0. The Battery Voltage section has VBAT checked and highlighted, with other settings like Minimum Cell Voltage (3.3) and Maximum Cell Voltage (4.3) also visible.

Enabled	Feature	Description
<input type="checkbox"/>	MOTOR_STOP	Don't spin the motors when armed
<input checked="" type="checkbox"/>	ONESHOT125	ONESHOT ESC support (disconnect ESCs, remove props)
<input checked="" type="checkbox"/>		Disarm motors regardless of throttle value (When arming via AUX channel)
1025		Minimum Throttle
1500		Middle Throttle [RC inputs center value]
1980		Maximum Throttle
1000		Minimum Command

Enabled	Feature	Description
<input checked="" type="checkbox"/>	VBAT	Battery voltage monitoring
3,3		Minimum Cell Voltage
4,3		Maximum Cell Voltage
3,5		Warning Cell Voltage
110		Voltage Scale

Additionally, if you are planning to install LEDs on your frame, you can enable "LED Strip" support in CleanFlight. It allows you to directly connecting WS2812B, WS2812, and WS2811 based RGB LEDs to the COLIBRI RACE flight control and configure their color.



---

## Driver installation

The COLIBRI RACE is one of the first flight controllers that natively supports USB. In newer operating systems (Windows 10, Mac OS X 10.10) there are no drivers required to enable configuration. However, for the most users a new driver has to be installed manually. Download and install the following driver.

- [STM32 VCP Driver Download \(Windows only\)](#)

Some computers may not immediately recognize the new STM32 VCP device after installing the driver. You may need to go into your [Device Manager](#) and updating the driver directly. Find a yellow icon next to the USB device, right-click it and select "Update Driver". Navigate to the following folder to locate the correct driver:

```
C:\Program Files (x86)\STMicroelectronics\Software\Virtual comport driver\
```

## Updating firmware using TBS Agent (recommended)

Getting the latest firmware flashed via TBS Agent is a fast and easy process. This is the recommended method of updating the COLIBRI RACE.

1. Install the latest STM32 VCP drivers, as shown in the previous section, from <http://www.st.com/web/en/catalog/tools/PF257938>
2. Open [TBS Agent](#) and click on the "UPDATE COLIBRI RACE"-tab
3. (Pressing boot button for update the FC is not necessary anymore with latest Agent revision, unless the firmware has been completely erased) **(NEW!)**

Press and hold the "BOOT"-button on the COLIBRI board while connecting the micro-USB cable to the side of the main assembly to enter DFU programming-mode.

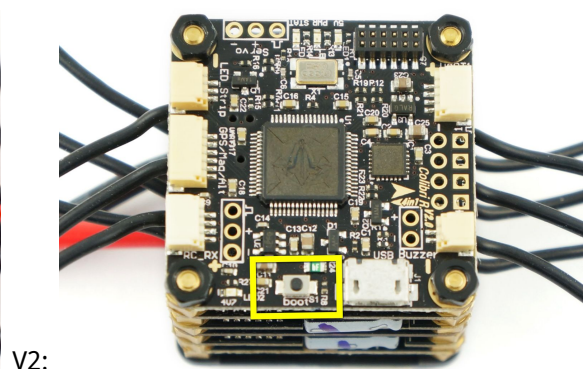
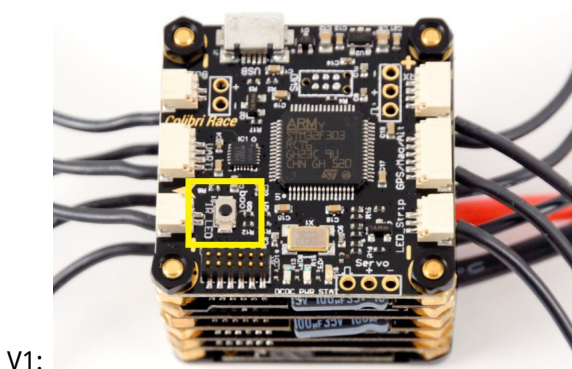

4. Select a firmware from the drop-down menu (select "Vendetta" especially made for the TBS VENDETTA, these include pre-tuned settings) and click "UPDATE" - the process should finish within 15 seconds. To access beta-versions, press F1 and check off "Include beta releases".

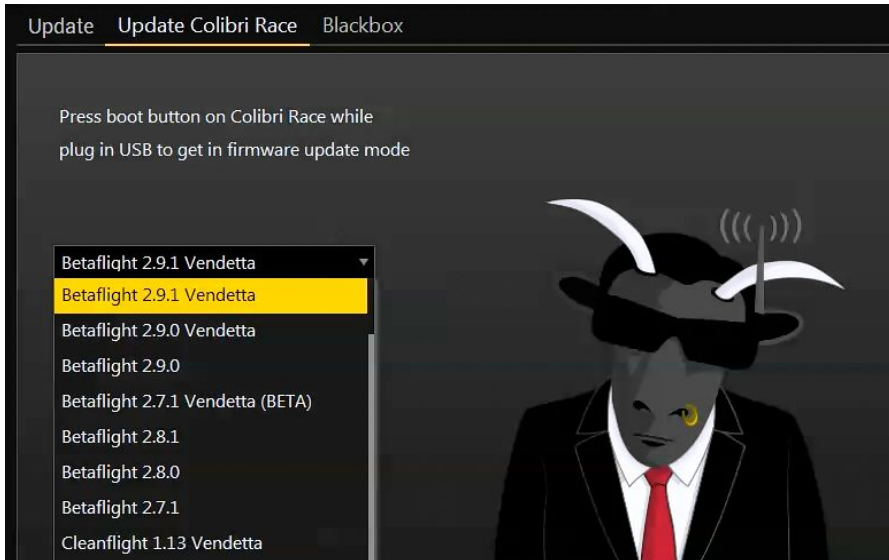

5. Now, restore or configure your receiver, flight modes, PID, beeper, and LEDs settings for the particular firmware version in [CleanFlight/BetaFlight](#) as normal.

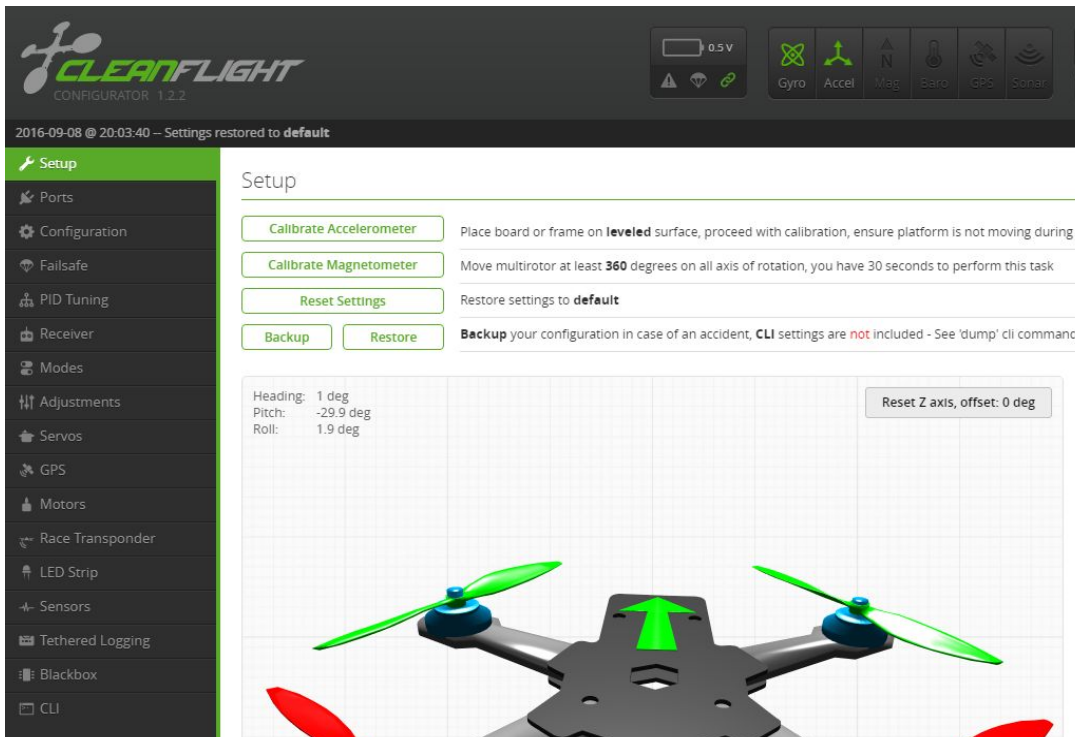

## Updating firmware using CleanFlight

The TBS COLIBRI runs with a slightly customized CleanFlight, which you can grab here:

- <http://www.team-blacksheep.com/powercube/colibri-latest.zip>

If you do not need features such as BST or MultiFlash, or until these features are merged into the CleanFlight project, you can use the standard CleanFlight builds directly from the CleanFlight Configurator.

### Upgrade via CleanFlight

The latest version of CleanFlight Configurator supports flashing firmware for the COLIBRI RACE. However, the code for BST (communication with TBS CORE PRO) and the passthrough/1wire technology has not yet merged into the CleanFlight project. Therefore, we have a custom HEX file in the [colibri-latest.zip](http://www.team-blacksheep.com/powercube/colibri-latest.zip). Connect the USB with the “boot” button pressed. Alternatively, you can also use BetaFlight.

Then, go to the “Firmware Flasher”-tab. If you use a BST-supported firmware it can be selected by using “Load Firmare (local)” button. If you do not need BST-support, use “Load Firmware (online)” to download the normal CleanFlight firmware, then click “Flash Firmware” begin the programming process.

The screenshot shows the CleanFlight Configurator Firmware Flasher interface. The top bar includes the CleanFlight logo, version 1.2.3, and system information: "2016-09-29 @ 9:18:22 PM - Running - OS: MacOS, Chrome: 53.0.2785.116, Configurator: 1.2.3". The main area is titled "Firmware Flasher" and contains several settings:

- Board: COLIBRI RACE (dropdown menu)
- Firmware: v1.13.0 - COLIBRI RACE - 2016-6-5 22:20 (stable) (dropdown menu)
- Options:
  - No reboot sequence (Enable if you powered your FC while the bootloader pins are jumpered or have your FC's BOOT button pressed.)
  - Flash on connect (Attempt to flash the board automatically (triggered by newly detected serial port).)
  - Full chip erase (Wipes all configuration data currently stored on the board.)
  - Manual baud rate: 256000 (Manual selection of baud rate for boards that don't support the default speed or for flashing via bluetooth. Note: Not used when flashing via USB DFU)
  - Show unstable releases (Show Release-Candidates and Development Releases.)

A red warning banner is displayed with the following text:

**Warning**

Please do **not** try to flash **non-cleanflight** hardware with this firmware flasher.  
Do **not** **disconnect** the board or **turn off** your computer while flashing.

**Note:** STM32 bootloader is stored in ROM, it cannot be bricked.  
**Note:** Auto-Connect is always disabled while you are inside firmware flasher.  
**Note:** Make sure you have a backup; some upgrades/downgrades will wipe your configuration.  
**Note:** If you have problems flashing try disconnecting all cables from your FC first, try rebooting, upgrade chrome, upgrade drivers.  
**Note:** When flashing boards that have directly connected USB sockets (SPRacingF3Mini, Sparky, ColibriRace, etc) ensure you have read the USB Flashing section of the Cleanflight manual and have the correct software and drivers installed

**IMPORTANT:** Ensure you flash a file appropriate for your target. Flashing a binary for the wrong target can cause **bad** things to happen.

At the bottom, there are three buttons: "Flash Firmware", "Load Firmware [Online]", and "Load Firmware [Local]".



## CleanFlight Configurator issues

CleanFlight configurator runs as a Chrome app and therefore is at the mercy of Chrome's driver support. In some instances, the STM drivers will not work. Even though the flight controller starts in DFU mode, CleanFlight configurator may not recognize your board. In this case, the instructions outlined here need to be followed:

<https://github.com/cleanflight/cleanflight-configurator/pull/250#issuecomment-146756746>

## Upgrade via DFU (developer use)

Use the following procedure to update the COLIBRI firmware using DFuSE, a free tool from ST Microelectronics. It is the most "barebones" method you can use.

1. [Download STM DFU loader](#) (Windows required)
2. Install and execute the DFU loader
3. Press the boot button on COLIBRI RACE while connecting USB - with no other power connected
4. Your COLIBRI should now show up as a DFU device inside the tool (see right)
5. [Download the latest COLIBRI firmware](#)
6. Select "Choose" and select downloaded .DFU file
7. Click "Upgrade" and wait for the software to finish uploading
8. Re-plug your USB cable to start using the new firmware

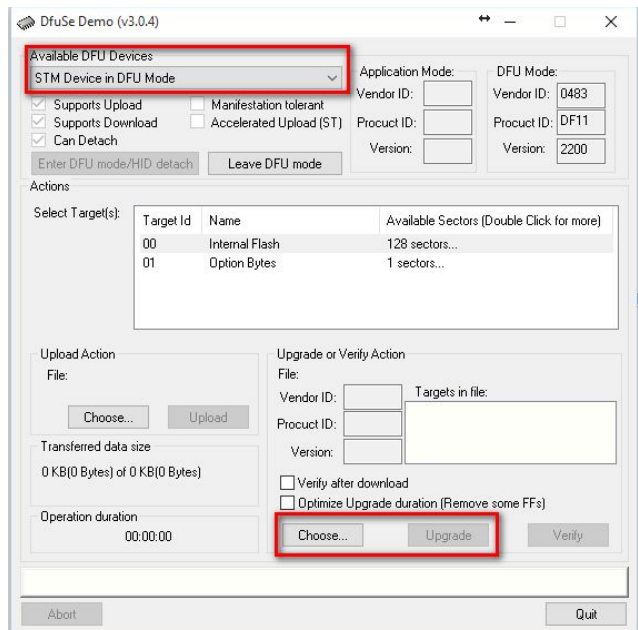

---

## TBS BULLETPROOF 25A ESC - Speed control

The next in line of the most innovative, reliable and powerful ESC for multirotors. The first 2S to 6S capable TBS BULLETPROOF ESC, forged and optimized for racing. The best thing about those ESCs - no soldering and a very short manual. There is nothing to set up, configure, or solder. Simply plug your motors into the provided 2mm bullet connector sockets, check motor spin direction and you are all set. More seasoned builders and pilots may wish to directly solder motor cables to the ESC, for greater reliability.

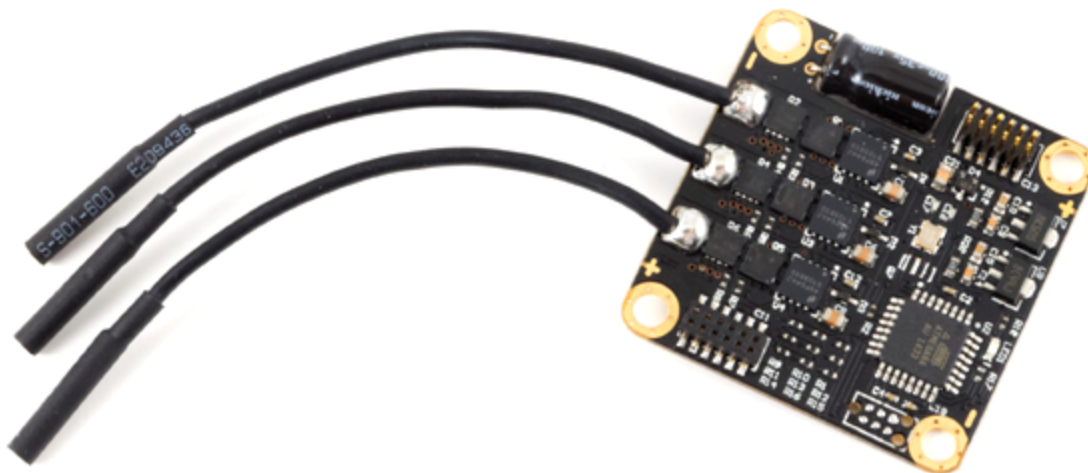

The ESCs stack into the TBS POWERCUBE in alternating fashion. The location in the stack determines which motor they are assigned to - assignment starts closest to the flight controller (from #1) and downward.

### Configuration

The ESCs are configured via the BLHeli Suite, using either “escprog sk [1-4]” for Cleanflight, or “1wire [1-4]” in the Cleanflight CLI. ESC calibration is not required, and is disabled by default.

The min throttle is 1025, and max throttle is 1980, in case you have changed those values.





---

## Firmware upgrades

Make sure your FC firmware supports BLHeli port forwarding. We recommend any Betaflight firmware >V2.7.

1. Download/Open up latest BLHeli Tool (<https://www.mediafire.com/folder/dx6kfaasyo24l/BLHeliSuite>)
2. Select Atmel/Silabs Interface inside BLHeli tool: either Atmel or Silabs with addition "Cleanflight"
3. Select COM port of your FC - make sure COM port is not connected to Betaflight/ Cleanflight tool
4. Hit Connect
5. Hit Check
6. All your ESC should be listed
7. Flash them, using Flash BLHeli button
8. Make sure you restore the settings after flashing them, continue always hit enter will continue that way

The latest TBS POWERCUBE firmware for TBS BULLETPROOF and TBS COLIBRI RACE:

- <http://www.team-blacksheep.com/powercube/colibri-latest.zip>

### ESC / Interface table

PowerCube ESC	Chipset	Bootloader	BLHeli Interface
TBS BULLETPROOF 20A ESC	Atmel	SimonK	5 - ATMEL SK Bootloader (Afro/Turnigy USB Linker)
TBS BULLETPROOF 20A ESC	Atmel	BLHeli	6 - Cleanflight passthrough
TBS BULLETPROOF 4in1 ESC	Silabs	BLHeli	6 - Cleanflight passthrough



---

# TBS POWERCUBE PDB V2 - Power distribution

This board measures current and controls power distribution across the entire TBS POWERCUBE, provides regulated and filtered power for the ESCs, flight controller and FPV system.



V1:

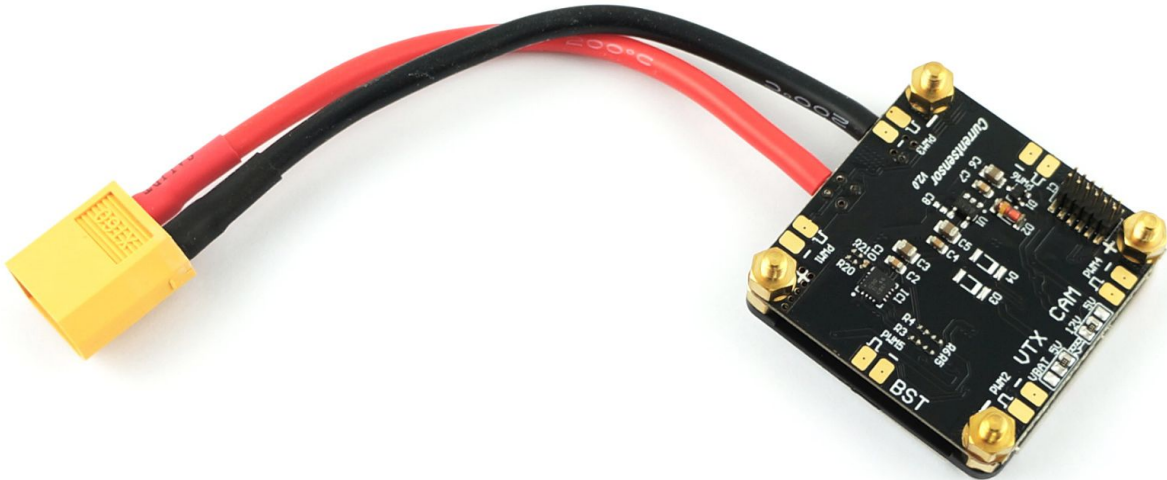

V2:



---

## Selecting VTX and CAM voltage

The output voltage for the VTX and CAM ports can be selectable on the PCB. By default is the CAM port set to 12V and the VTX set to 5V. If your equipment requires a different voltage (normally printed on the device or in the specifications), you have to switch the solder jumper bridge to the right voltage (5V or 12V.) You can even change the voltage for the VTX to VBatt if your video transmitter has an on-board regulator or requires more power than the TBS DCDC board can provide.

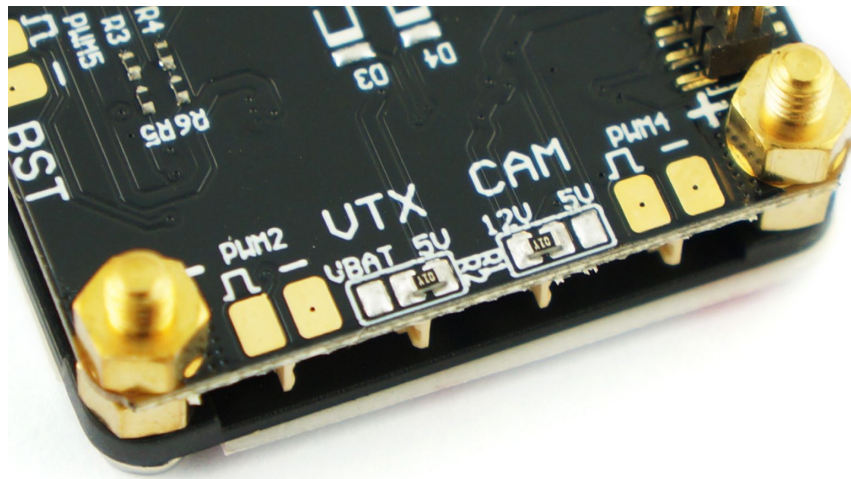

If you are experienced with soldering you can make the change without disassembling the stack, but it is recommended to disassemble the PDB layer to get direct access to the solder bridge.

To change the output voltage, perform the following steps:

1. Disassemble the stack to get access to the top of the PDB layer (remove flight controller and all the ESC layers)
2. Desolder the bridge resistor and clean off any excess solder
3. Apply a small amount of solder to the center pad and the pad of the voltage you want to select.
4. Sweep across until the blobs join



---

## Connecting FPV camera and transmitter

There are two ports on the PDB board which are for the FPV camera and video transmitter. Any TBS camera and transmitter is directly supported and plugs into the connector (Molex Picoblade) - be sure the output voltage is right for the equipment you are going to connect.

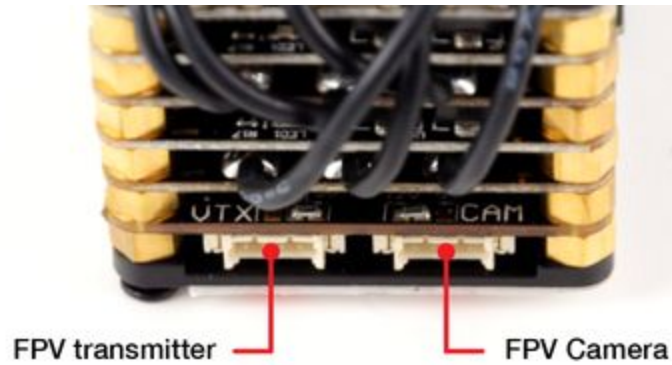

By looking at the side of the PDB layer, you can see "VTX" and "CAM" marked on the other side of the board. Plug the FPV transmitter and camera into their corresponding port.

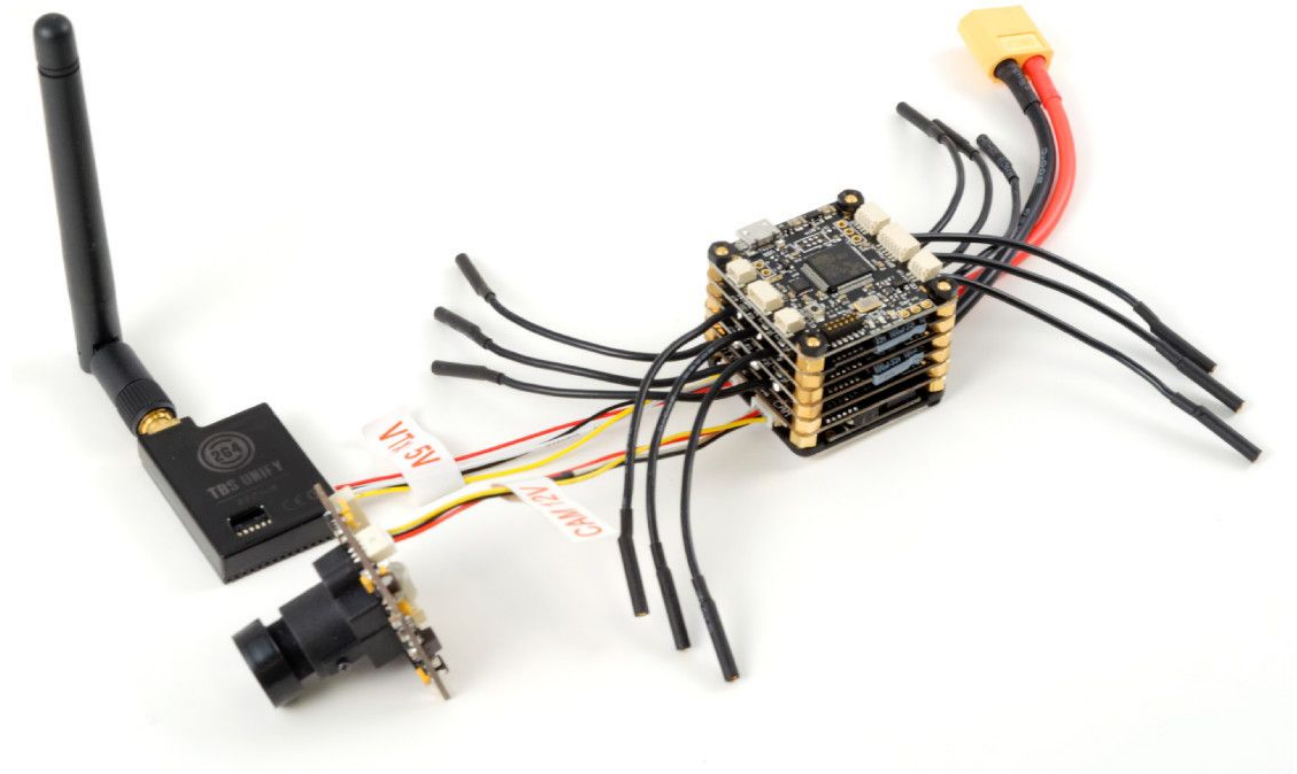

---

## Making older TBS PDB V1 compatible with newer TBS COLIBRI FC

The newer TBS POWERCUBE COLIBRI (v1.2, V2.0 or above) is not compatible with older TBS PDB V1 out of the box. It will require one small modification.



All that needs to be done is to cut off one pin on the TBS POWERCUBE PDB (non-v2.0) stacking header. The pin is the extra pin 11, 12V DC supply. This pin is an additional 5V pin on newer TBS PDB V2 boards.

Unless you are using an older flight controller (V1.0, V1.1), you will not need to make any changes. Owners of POWERCUBE FPVision layer or PDB V2.0 will not need to make any modifications at all, no matter what FC version is used.

The following table shows when to remove the pin and when to leave it.

Connecting:	COLIBRI V1.0, V1.1	COLIBRI V1.2, V2.0, newer
PDB V1.0	✘ No change, leave pin	✓ Cut pin
PDB V2.0	✘ No change, leave pin	✘ No change, leave pin
FPVision	✘ No change, leave pin	✘ No change, leave pin



---

## Troubleshooting FPV Transmitter / Camera

- **Only static on receiver, or no video (PDB V1 only)**

Verify that you have a working 5V and 12V supply by using a multimeter and measuring on the dedicated 5V/12V/GND pads near the BST connector.

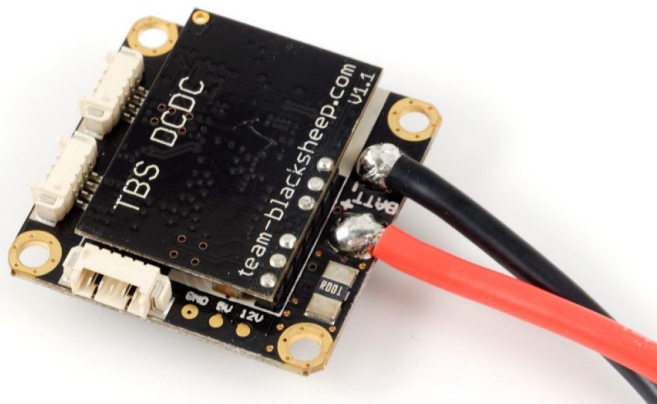

In case the 5V and 12V supply line is interrupted, you can try to fix it by soldering the 6 pin headers that connect the power distribution board with the TBS DCDC, especially on the TBS DCDC side.

- **Lines in video**

In some instances high-draw R/C receivers or telemetry devices are able to introduce interference into the video feed. In this case, it is recommended to place a LC filter in line with the FPV transmitter line. For very noisy R/C receivers such as the FrSky X4RSB or D4R-II, there is no solution other than powering the receiver from a separate 5V supply.



---

## TBS Elite Bundle / External ESC PDB layer

If you prefer, or need to use, your own external ESCs for a customized setup, you can do this by using the special external ESC board for the POWERCUBE. It allows you to solder 4 ESCs to the board, including the control signal.

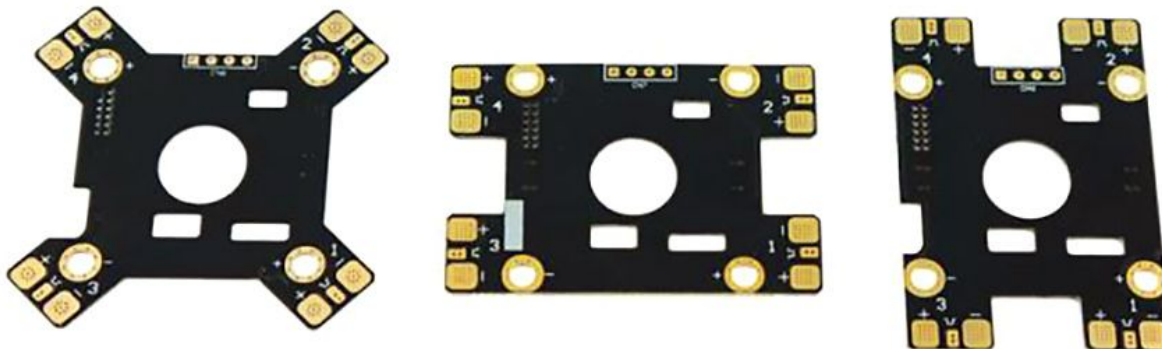

You will need a TBS COLIBRI RACE (FC) and the TBS DCDC PDB or TBS FPVision for a complete working quadrotor setup.



The installation is simple. The flight control has 4 signal pins (holes) that match to the 4 signal pins on the PDB. Simply drop the FC and the PDB onto the stack together (no spacers in between!) and then solder each of the signal pins (holes) together with the PDB on the bottom.

Add ESCs by soldering the ESC power positive/negative and control signal wires to the designated pads on the board, and then to the ESC. The negative signal lead can be soldered to the negative power pad if desired. In the case of the TBS BulletProof 25A, the negative signal wire is not needed.



---

## TBS POWERCUBE Drag Race Shield

With motors and propellers becoming more and more power hungry, the Drag Race capacitor shield adds 2200uF of capacitance to your power supply. This works essentially as a short term energy storage, with huge discharge capabilities.

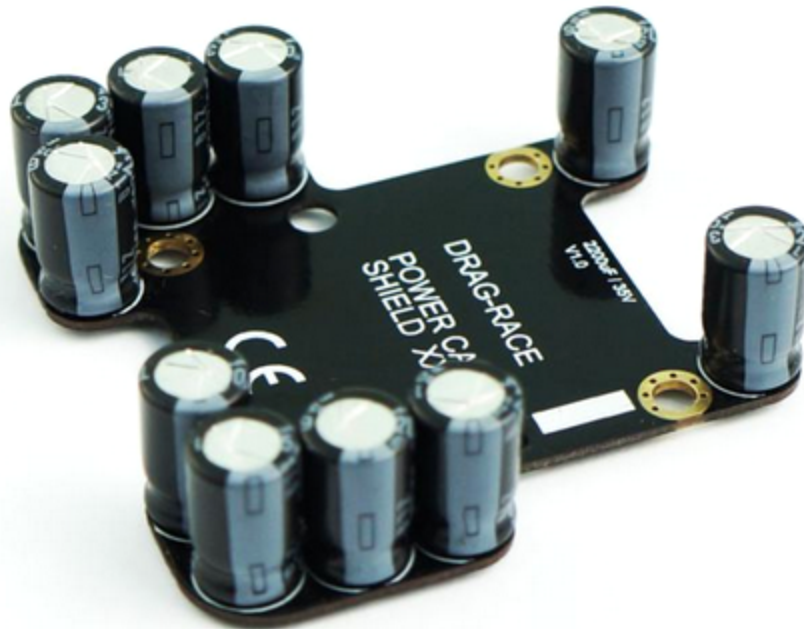

For drag races and full throttle aficionados, the TBS Drag Race Shield adds a whopping 2200uF to your power rail with 4 simple screws. It helps to stabilize your battery voltage despite amperage spikes. This helps with the quad's stability, ESC lifetime, and punch-out energy.





---

## Connecting TBS equipment

There is an issue when you want to run BST devices like the GPS or BLACKBOX direct without a CORE PRO. Most of the BST devices needs 5V which the CORE PRO provides. The CROSSFIRE RX does not power the BST line when 5V is applied to the servo connectors.

The following explains the required power needs:

- TBS BLACKBOX - Can be powered by the BST 5V or by the Flight Controller over the ext. FC port
- TBS GPS - Can only be powered by the BST 5V
- TBS CURRENT SENSOR - Provides VBatt but needs BST 5V to run itself
- TBS CROSSFIRE RX - Can be powered over one of the eight servo connectors or by BST 5V
- TBS CORE PRO / FPVISION - This is only device is providing 5V on the BST line

Power type:	BST 5V	VBATT	ESC BEC 5V	FC 5V
TBS CROSSFIRE	✓ PWR IN		✓ PWR IN	
TBS BLACKBOX	✓ PWR IN			✓ PWR IN
TBS GPS	✓ PWR IN			
TBS CORE PRO / FPVISION	✓ PWR OUT	✓ PWR IN		
TBS CURRENT SENSOR	✓ PWR IN	✓ PWR OUT		
TBS BULLETPROOF ESC (SET)			✓ PWR OUT	



---

## Connectivity with TBS CORE PRO OSD

One of the biggest advancements with the TBS POWERCUBE is the connectivity to the TBS CORE PRO / FPVision, a next-generation OSD system. The software update that we released together with the TBS POWERCUBE enables the CORE PRO (V1.24 and later) to access and modify CleanFlight settings from the CORE OSD, as well as other handy features.

### TBS CORE PRO Connection

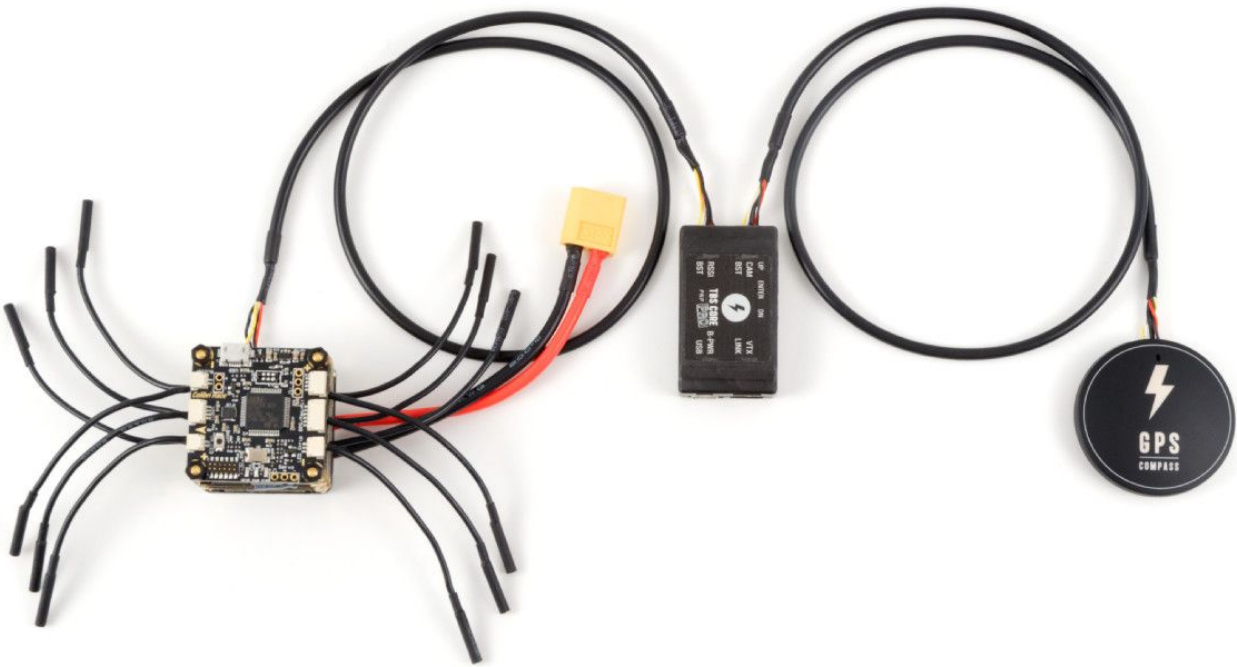

The POWERCUBE has a BST connector on the PDB layer which allows a connection to the CORE PRO. This connection provides battery power and current sensor data for the OSD on the CORE PRO. The FPV transmitter and camera must be connected to the CORE PRO not the POWERCUBE for the OSD to work.

See the TBS CORE PRO manual for further details on selecting output voltage and configuring the OSD:

<http://www.team-blacksheep.com/tbs-core-pro-manual.pdf>

Connect a suitable length cable between the CORE PRO and POWERCUBE (long and short cables supplied). Connect a GPS to the CORE PRO if you require position data. If you run out of BST ports, you can use a TBS 4-way BST splitter to get more ports.



---

## Entering OSD configuration menu

After the initial calibration is done, the main OSD overlay will show and the CORE PRO is ready to be configured.

1. To enter the OSD configuration menu, hold the throttle stick down-left for 4 seconds (mode 2)



2. A countdown will let you know that you are about to enter the OSD menu

## RC Calibration (mandatory)

R/C Calibration is required to teach the TBS CORE PRO and the flight controller which stick performs which action on your remote control. RC Calibration comes up either automatically if you are running the CORE PRO for the first time, or it is available in the R/C menu under “Flight Controller” → “Calibration” → “RC Calibration Wizard” if you need to access it again.

The default settings for RC calibration match the CleanFlight/BetaFlight settings. If your R/C matches these settings you may choose to skip the R/C calibration setup step.

### Calibrate new setup

The CORE PRO is by default expecting an SBUS signal since this is the most commonly used protocol nowadays among FPV racers. If you are using any other receiver such as CROSSFIRE CRSF, Spektrum DSM satellite, or any PPM-compatible receiver, press the ENTER key of the CORE PRO to cycle through the available signal options.

A restart of the flight controller is required so please allow it some time. At the same time for it to load, center all of your R/C sticks, and the RC Calibration Wizard will launch. Follow the instructions to assign the right RC channels. After these steps you will be able to control the OSD with your Roll- and Pitch-stick.

(procedure shown on the next page)



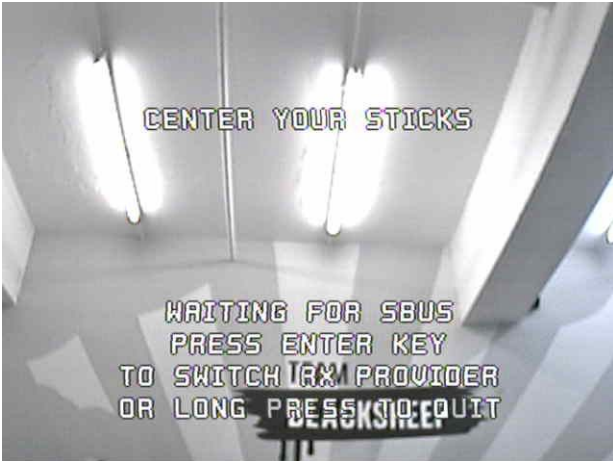

Centering your sticks will start the countdown. If you are not using the currently-active RX provider (in this case SBUS), push the center (Enter) button of the CORE PRO to cycle through the available options.

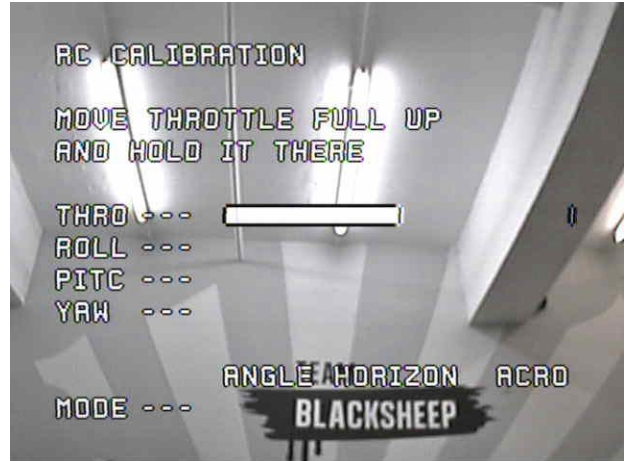

Follow the instructions on the screen and move your sticks accordingly. If the direction does not match, it needs to be adjusted in your R/C radio configuration. Cleanflight can not interpret reversed channels.

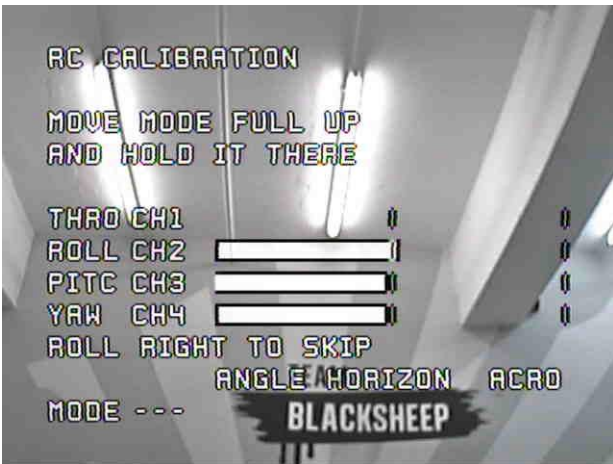

Calibrating flight modes is not required. You can ROLL RIGHT to skip, or assign a free 3-pos switch in your R/C to take advantage of this feature. Keep in mind that the default flight mode for Cleanflight is ACRO.



---

## Read RC data from existing setup

If you already have everything set up on your POWERCUBE and you are just adding the CORE PRO, select "READ CLEANFLIGHT RC DATA" in the CORE PRO menu and the CORE PRO will apply the settings from your CleanFlight setup.

The same process will be run if you choose to SKIP a mandatory calibration procedure. After these steps you will be able to control the OSD with your Roll- and Pitch-stick.

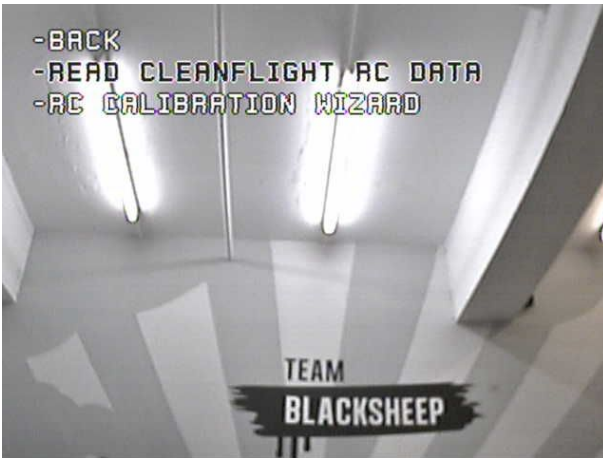

---

## Maintenance

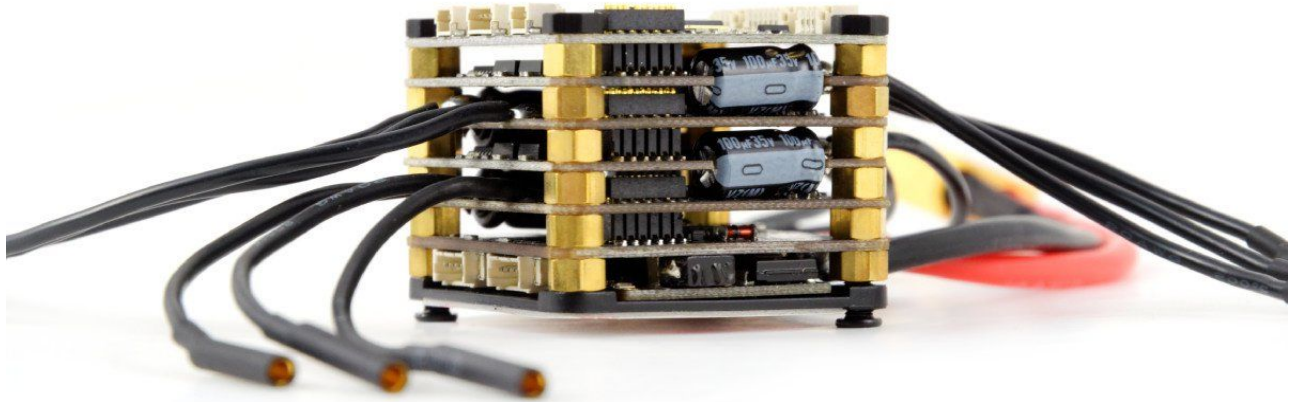

### Replacing components

The TBS POWERCUBE comes pre-assembled out of the box. The stand-offs and nuts require a 5mm hex driver. TBS has some specialized tools available for super-fast and safe assembly. Without specialized tools, please take extra care when opening nuts that are close to the internal BUS-port (black pin header socket) and look out for small SMD components close to the stand-offs. The torque used in the assembly is 0.4Nm, if you have adjustable torque tools we suggest to use the same setting.

The flight control and power distribution boards are “terminating layers” - meaning they are the head and the tail of the cube. In between are the ESCs, which are stacked on top of each other with 180 degree offset, this means the motor wires exit left and right in alternating fashion. The ESCs know their spot in the TBS POWERCUBE, so starting from the top down they are tied to motor #1 to #6 according to their position in the stack from the flight control layer. Take extra care when putting the TBS POWERCUBE back together - the pin header socket sits down on the pins from the layer below. Make sure the headers line up before applying pressure to avoid bending the pins.

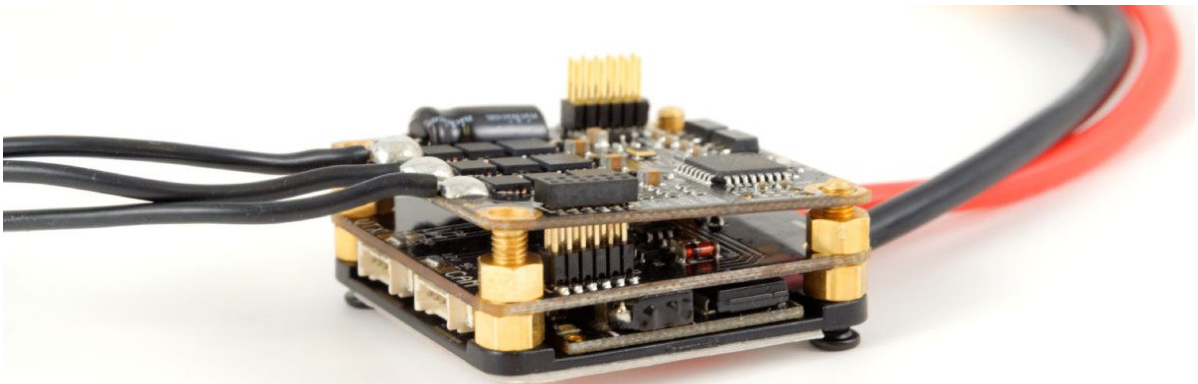

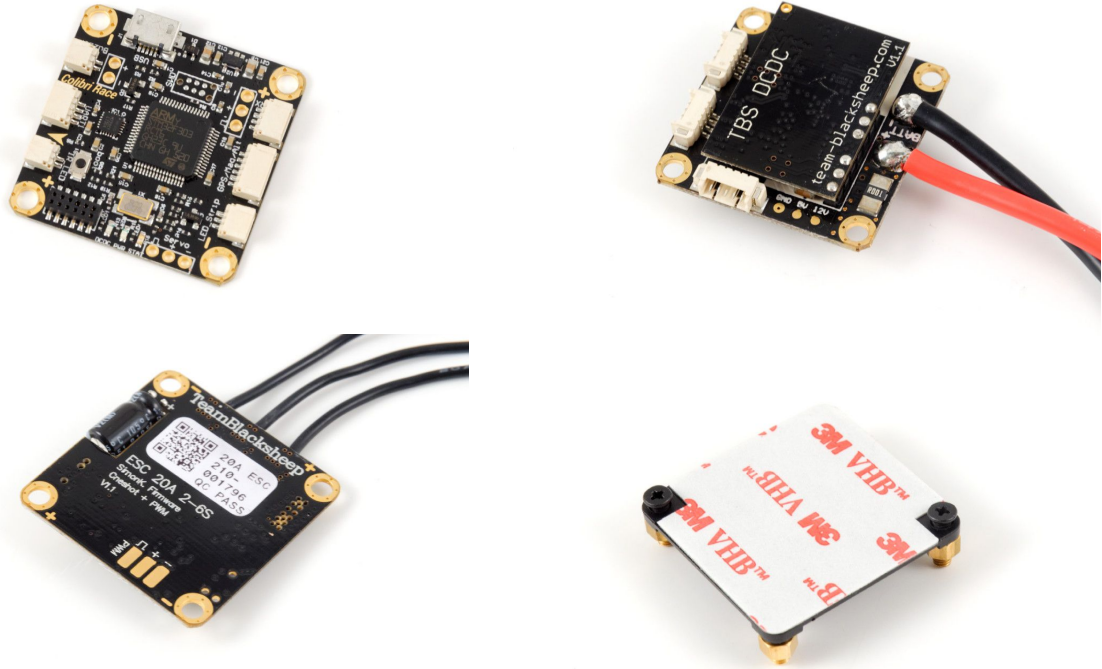

## Tuning

The stock standoffs are made from brass to keep money in your pockets or rainy day funds. For the serious weight aficionado, aluminum-gold based standoffs are available. They will shed around 12g off the total AUV, while improving conductivity and thus the maximum power throughput.

Further optimization can be done by using conformal coating on the PCB surface, to protect your ESCs against the elements. Be sure to add tape to all parts that need to remain exposed, such as the standoff holes, any sockets, pin headers or connectors. Weatherproofing your setup can substantially increase its life-time, especially in winter or when flying over wet grass or in industrial areas with metallic trash lying around that could short out components.

## Troubleshooting

- **Carbon burnt**

Check for electrical short, specially the motor phases shorted to Frame. Motor mounting screws too long so that they screwed up into the motor windings?



---

## Good practices

We have compiled a list of all of practices which have been tried and tested in countless environments and situations by the TBS crew and other experienced FPV pilots.

Follow these simple rules, even if rumors on the internet suggest otherwise, and you will have success in FPV.

- Start with the bare essentials and add equipment one step at a time, after each new equipment was added to proper range- and stress tests.
- Do not fly with a video system that is capable of outperforming your R/C system in terms of range.
- Do not fly with a R/C frequency higher than the video frequency (e.g. 2.4GHz R/C, 900MHz video).
- Monitor the vitals of your plane (R/C link and battery). Flying with a digital R/C link without RSSI is dangerous.
- Do not use 2.4GHz R/C unless you fly well within its range limits, in noise-free environments and always within LOS. Since this is most likely never the case, it is recommended to not use 2.4GHz R/C systems for longer range FPV.
- Do not fly at the limits of video, if you see noise in your picture, turn around and buy a higher-gain receiver antenna before going out further.
- Shielded wires or twisted cables only, anything else picks up RF noise and can cause problems.
- When using powerful R/C transmitters, make sure your groundstation equipment is properly shielded.
- Adding Return-To-Home (RTH) to an unreliable system does not increase the chances of getting your plane back. Work on making your system reliable without RTH first, then add RTH as an additional safety measure if you must.
- Avoid powering the VTx directly from battery, step-up or step-down the voltage and provide a constant level of power to your VTx. Make sure your VTx runs until your battery dies.
- Do not power your camera directly unless it works along the complete voltage range of your battery. Step-up or step-down the voltage and provide a constant level of power to your camera. Make sure your camera runs until your battery dies.
- A single battery system is safer than using two dedicated batteries for R/C and FPV. Two batteries in parallel even further mitigate sources of failure.
- For maximum video range and “law compatibility”, use 2.4GHz video with high-gain antennas.
- When flying with R/C buddies that fly on 2.4GHz, or when flying in cities, it is perfectly possible to use 2.4GHz video provided you stick to the channels that do not lie in their band (CH5 to CH8 for Lawmate systems, available from TBS).





- 
- Do not use diversity video receivers as a replacement for pointing your antennas, diversity should be used to mitigate polarization issues.
  - Improving the antenna gain on the receiver end is better than increasing the output power (except in RF-noisy areas). More tx power causes more issues with RF on your plane. 500mW is plenty of power!
  - Try to achieve as much separation of the VTx and R/C receiver as possible to lower the RF noise floor and EMI interference.
  - Do not buy the cheapest equipment unless it is proven to work reliably (e.g. parts falling off, multitudes of bug fix firmware updates, community hacks and mods are a good indicator of poor quality and something you do NOT want to buy for a safe system). Do due diligence and some research before sending your aircraft skyward.

Manual written and designed by ivc.no in cooperation with TBS.

